



LINCOLN MOTORCYCLE AND CAR CLUB LTD  
**BRUCE ROBINSON ROAD RALLY 14/15th FEB 2009**  
A round of the ANEMMC, EMAMC & ANCC  
Road Rally Championships 2009



Route Card: 1

Handout at: MTC 1

CRO

VERY QUIET THROUGHOUT THIS SECTION PLEASE, ESPECIALLY LEAVING MTC 1

Proceed to NTC 2 **via**:

1. GW Turn Right out of car park.
2. GW, turn left onto A631 @ 11308885
3. Turn Left onto B1202 @ 10908905 (Traffic Lights)
4. Keep on the B1202 heading south out of Market Rasen
5. Quiet Linwood
6. Turn onto yellow @ 10908625 (Quiet)
7. NTC 2 @ 104861

1<sup>st</sup> Half rejoin points:

TTC 12 @ Map 122 W 28757025

TTC 16 @ Map 122 SE 26157765

MTC 2 and Petrol Halt @ Map 113 14209040



LINCOLN MOTORCYCLE AND CAR CLUB LTD  
**BRUCE ROBINSON ROAD RALLY 14/15th FEB 2009**

A round of the ANEMMC, EMAMC & ANCC  
Road Rally Championships 2009



Route Card: 2

Handout at: NTC 2

CRO

**Via** the following in **Alphabetical** order to reach STC 3:

D) PCGT @ 096854	I) PCGT @ 08058340	J) STC 3@ 082831	F) Care @ LC	B) 10
G) 09	C) GW @ SH 25	E) 85	A) 86	H) 84

Then Neutral section to NTC4 via:

1. Very Quiet – Wickenby Village
2. 088819 (GW and Very Quiet)
3. 09258085 (GW)
4. NTC 4 @ 10558075 (airfield entrance)



Route Card: 3

Handout at: NTC4

AR

This is a Regularity Section!

Proceed to RTC 6 **via** the following in alphabetical order.

IRTC 5 will be found on the correct route.

**The Code Boards on this section are 2 lettered apart from the 5<sup>th</sup> and 6<sup>th</sup> PC's which are 5 lettered.**

<p>A</p> <p>Follow attached map.</p>	<p>B</p> <p>Leave attached map at 104802 and GW and turn right onto B1399. (CRO from now)</p>	<p>C</p> <p>Turn left at next coloured junction. <b>Very QUIET through Rand</b></p>
<p>D</p> <p>GW and turn left onto A158.</p> <p><b>RTC 6 @ N 112780</b></p>	<div data-bbox="1043 1308 1409 1554" data-label="Text" style="border: 1px solid black; padding: 5px;"> <p>Please Note:</p> <p>This route card was printed on A5 and attached to an A3 map of the airfield</p> </div>	



LINCOLN MOTORCYCLE AND CAR CLUB LTD  
**BRUCE ROBINSON ROAD RALLY 14/15th FEB 2009**  
A round of the ANEMMC, EMAMC & ANCC  
Road Rally Championships 2009



Route Card: 4

Handout at: RTC 6

AR

Proceed to **STC 7** via the following Tulips in **ascending numerical** order.

1) 	2) 	3) 	4) 	5) 
6) 	7) 	8) 	9) 	10) PC
11) 	12) 	13) 	14) 	15) PC
16) 	17) 	18) 	19) 	20) STC 7



LINCOLN MOTORCYCLE AND CAR CLUB LTD  
**BRUCE ROBINSON ROAD RALLY 14/15th FEB 2009**  
A round of the ANEMMC, EMAMC & ANCC  
Road Rally Championships 2009



Route Card: 5

Handout at: STC 7

CRO

Proceed to STC 8 and STC 9 **via** the longest route possible, whilst complying with the following Grid Lines and Spot Heights in **alphabetical** order:

N 20	B 22	O 74	M 20
J STC 8	H 34	I 76	E 18
D 37	A 16	C 17	P STC 9
F 19	L 75	G 45	K Quiet 200 meters before A158

GW @ 1<sup>st</sup> junction  
GW @ junction after instruction A  
GW @ instruction D  
GW @ instruction K

PC between instructions A and B



**LINCOLN MOTORCYCLE AND CAR CLUB LTD**  
**BRUCE ROBINSON ROAD RALLY 14/15th FEB 2009**  
 A round of the ANEMMC, EMAMC & ANCC  
 Road Rally Championships 2009



Route Card: 6

Handout at: STC 9

CRO

Proceed to STC 11 (STC 10 will be found on the correct route) **via** the Map  
References below in the following order:

5 Across, 3 Across, 2 Down, 1 Down, 11 Across, 10 Across, 9 Across, 4 Down, 6  
Down, 7 Down, 12 Across, 8 Down

PCNAM (Diagram below)										1	PC					1	PC								
3										1	9	8	5	7	2	9	5	4	1	9	1				
6										1	PC					5	1	9	9	7	3	2			
7										1	STC11					5	GW					3	5		
9										9	7	1	8	2	9	1	9	2	7	1	7	7	7	7	
5										9	9	0	9					2	1	2	2	2			
7										8	8	9	PC					10	1	8	9	7	2	4	8
11										1	8	7	5	7	2	6	5	0					5	5	
9										2		3												5	
5										12		1	9	8	5	7	2	6	5						

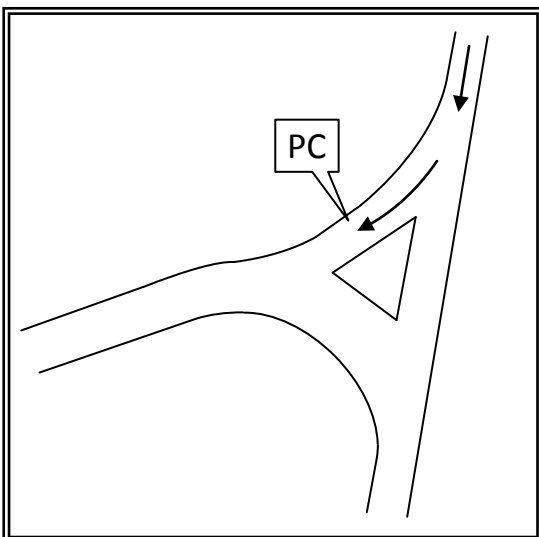

Then Transport section to TTC 12 via:

1. Quiet in village
2. GW and turn right onto Main road
3. Quiet in Horncastle
4. WSW 260695 E
5. TTC 12 @ 28757025



LINCOLN MOTORCYCLE AND CAR CLUB LTD  
**BRUCE ROBINSON ROAD RALLY 14/15th FEB 2009**

A round of the ANEMMC, EMAMC & ANCC  
Road Rally Championships 2009



Route Card: 7

Handout at: TTC12

AR

Proceed to STC 13, 14 and 15 **via** the following **Herringbones** in **alphabetical** order:

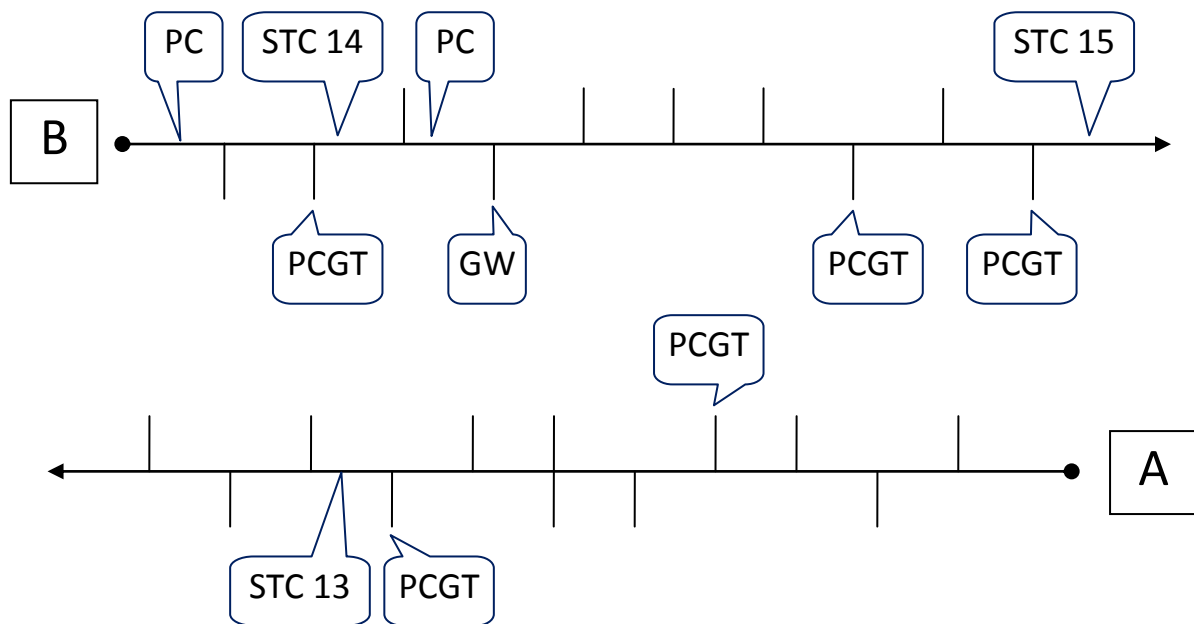

Then Transport section to TTC 16 via:

1. Turn right @ 30157330
2. Very Quiet in Fulletby
3. Turn right onto A153 @ SH 96
4. TTC 16 @ 26107765



**LINCOLN MOTORCYCLE AND CAR CLUB LTD**  
**BRUCE ROBINSON ROAD RALLY 14/15th FEB 2009**  
 A round of the ANEMMC, EMAMC & ANCC  
 Road Rally Championships 2009



Route Card: 8

Handout at: TTC 16

AR

Please choose, at your own discretion, either **TYPE A OR TYPE B** navigation to plot. Both give exactly the same information and route and so the choice is yours. Please note: Type A complies with EMAMC standards on navigation whereas Type B does not.

**TYPE A** – Proceed to STC 17 **via** the following map references in **alphabetical** order:

D 264786	J PCNAM in Layby @ car park @ 26508065	E 26407945	G 26107995 PCGT	C 25707865
B & I PC	F 26257980	A 260778	K STC 17 within 100m after box J	H 25958015

-----

**TYPE B** – Proceed to STC 17 **via** the following junctions in **alphabetical** order:

D YYY	J PCNAM in Layby @ car park @ 26508065	E YWY	G YYY PCGT	C YYY
B & I PC	F YWY	A YWY	K STC 17 within 100m after box J	H YYY



**LINCOLN MOTORCYCLE AND CAR CLUB LTD**  
**BRUCE ROBINSON ROAD RALLY 14/15th FEB 2009**  
 A round of the ANEMMC, EMAMC & ANCC  
 Road Rally Championships 2009





Route Card: 9

Handout at: STC 17

AR

Proceed to STC's 18, 19 and 20 **via** the grid below in the following order:

YC XB WD YA ZD WA ZA YD WC XA ZB XC ZA YB ZC ZA XD WB

	W	X	Y	Z
A	SH 81 (Care)	GW TL onto yellow	SH 65	PC
B	STC 20 @ 22958375	 150	Caution @ 90 L (Entering Welsdale Bottom)	STC 19
C	Red Dot x 8 (PC @ 5 <sup>th</sup> )	SH 149	PCNAM in Layby on LHS at Car Park	SH 137
D	GW @ 	GW @ Viking Way	SH 144	STC 18



LINCOLN MOTORCYCLE AND CAR CLUB LTD  
**BRUCE ROBINSON ROAD RALLY 14/15th FEB 2009**

A round of the ANEMMC, EMAMC & ANCC  
Road Rally Championships 2009



Route Card: 10

Handout at: STC 20

AR

**PLEASE DO NOT STOP TO PLOT AT THE 1<sup>st</sup> JUNCTION AS THERE ARE HOUSES.**

If you need to plot please stop at the cone on the left hand side which is approx 200 meters before the junction.

Proceed to STC 21 between northing 86 and the A157 by **avoiding** the following in **alphabetical** order:

- A) 250 metres radius of a visible earthwork
- B) 150 metres radius of a site of monument
- C) S

**PC just before GL 86**

-----  
Then Neutral section to NTC 22 via:

1. Turn left on A157
2. Quite Burgh on Bain
3. Turn right @ 21658635
4. NTC 22 @ 209879 (entrance to airfield)



LINCOLN MOTORCYCLE AND CAR CLUB LTD  
**BRUCE ROBINSON ROAD RALLY 14/15th FEB 2009**  
 A round of the ANEMMC, EMAMC & ANCC  
 Road Rally Championships 2009



To reach IRTC23 & RTC24 use the following:

- Via map across the airfield from NTC22
- Then GW turn **right** onto B1225 @ 195876
- GW @ SE 18558885
- Turn left onto white @ 18058955 (Quiet)
- RTC 24 @ ENE 17858945

IRTC23 on the correct route

This is a Regularity  
Section!

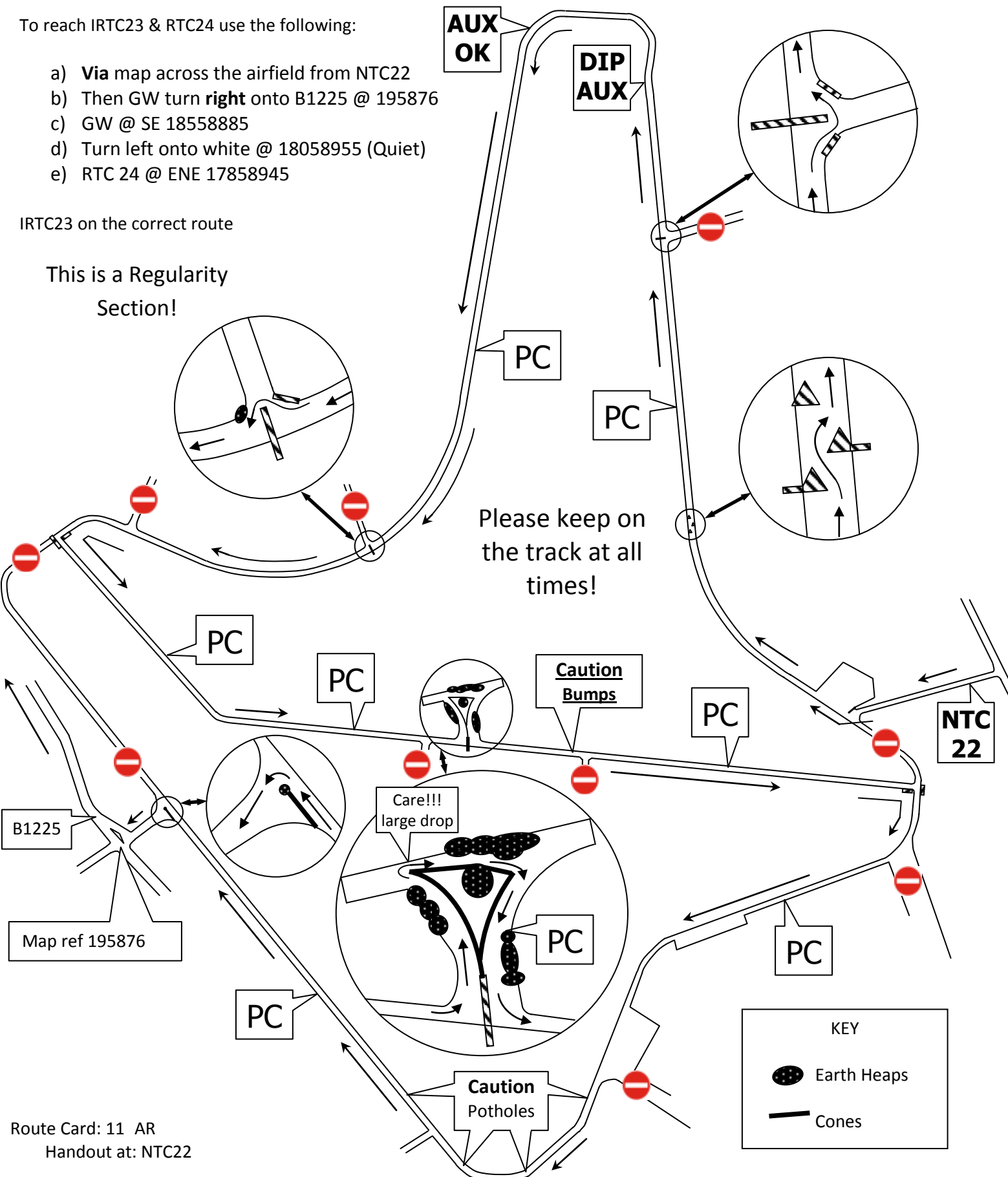

Route Card: 11 AR  
 Handout at: NTC22



LINCOLN MOTORCYCLE AND CAR CLUB LTD  
**BRUCE ROBINSON ROAD RALLY 14/15th FEB 2009**  
 A round of the ANEMMC, EMAMC & ANCC  
 Road Rally Championships 2009



Route Card: 12 AR  
 Handout at: RTC24

To reach IRTC25, RTC 26 + the Petrol halt use the following:

- A) **Via map** from RTC24 until the A631 @ 18208875
- B) GW, Turn right onto the A631
- C) RTC 26 @ 13658840 but is unmanned so proceed straight to petrol
- D) GW, turn right and quiet @ 109891 (traffic lights)
- E) Petrol Halt @14209040 (see diagram of petrol halt on reverse of this sheet)

This is a Regularity Section!

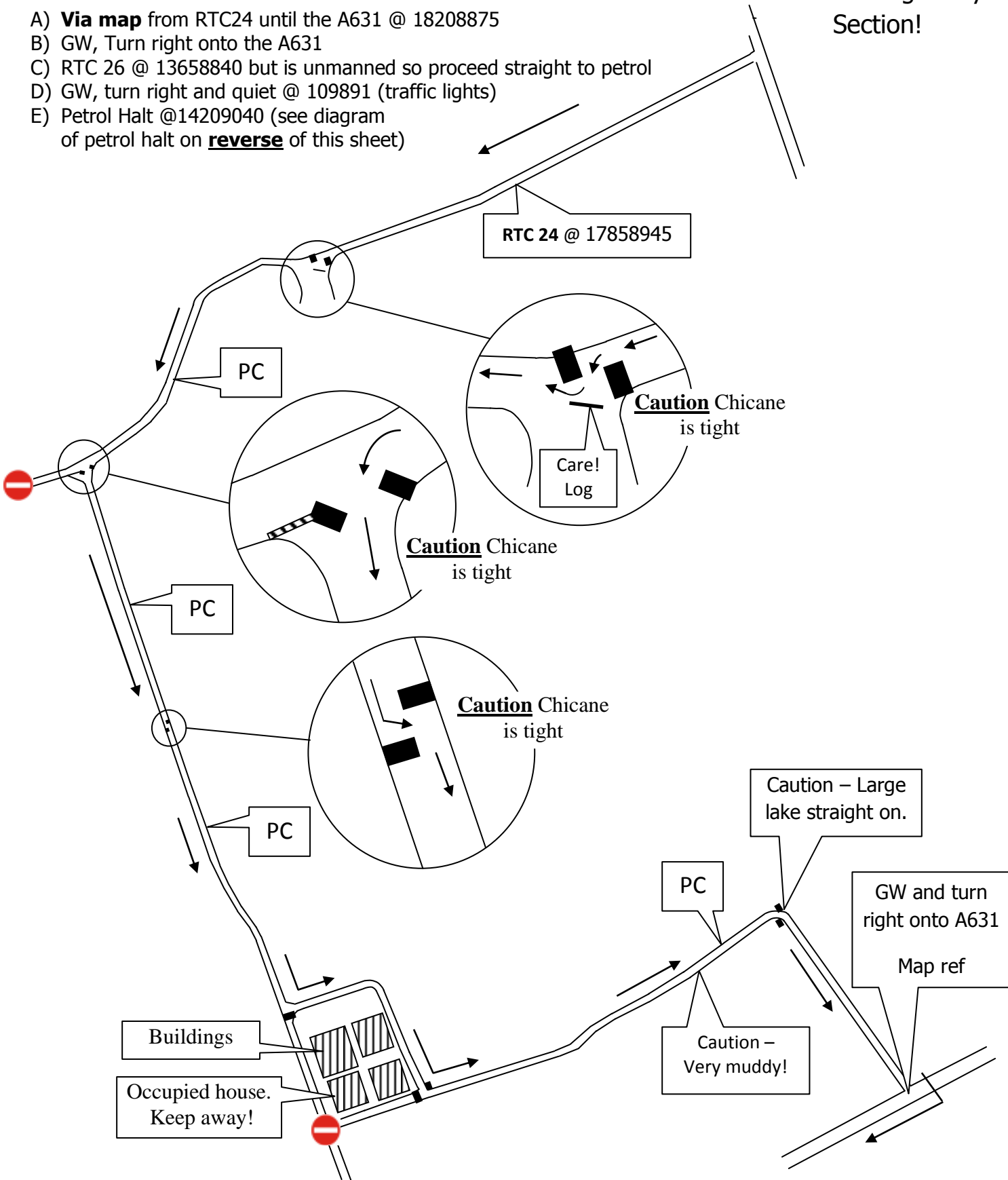

The Petrol station has limited space. Please fill up with fuel as quickly as possible. Then proceed to park neatly making sure you are not going to obstruct anyone. Please be very quiet as there are houses nearby! Hand in Time Card 1 and Passage Check Sheet 1 to the results car parked at MTC 2's position. The result's car will also marshal MTC 2.

If it is easier for a crewmember to get the time card signed on foot then please do it. You will be given a handout to get you to NTC 27 as you leave MTC 2. Your due time @ MTC 2 is **03.15 + your start number**. You should start the second half on your due time.

There will probably hot drinks and food available so PLEASE buy some!

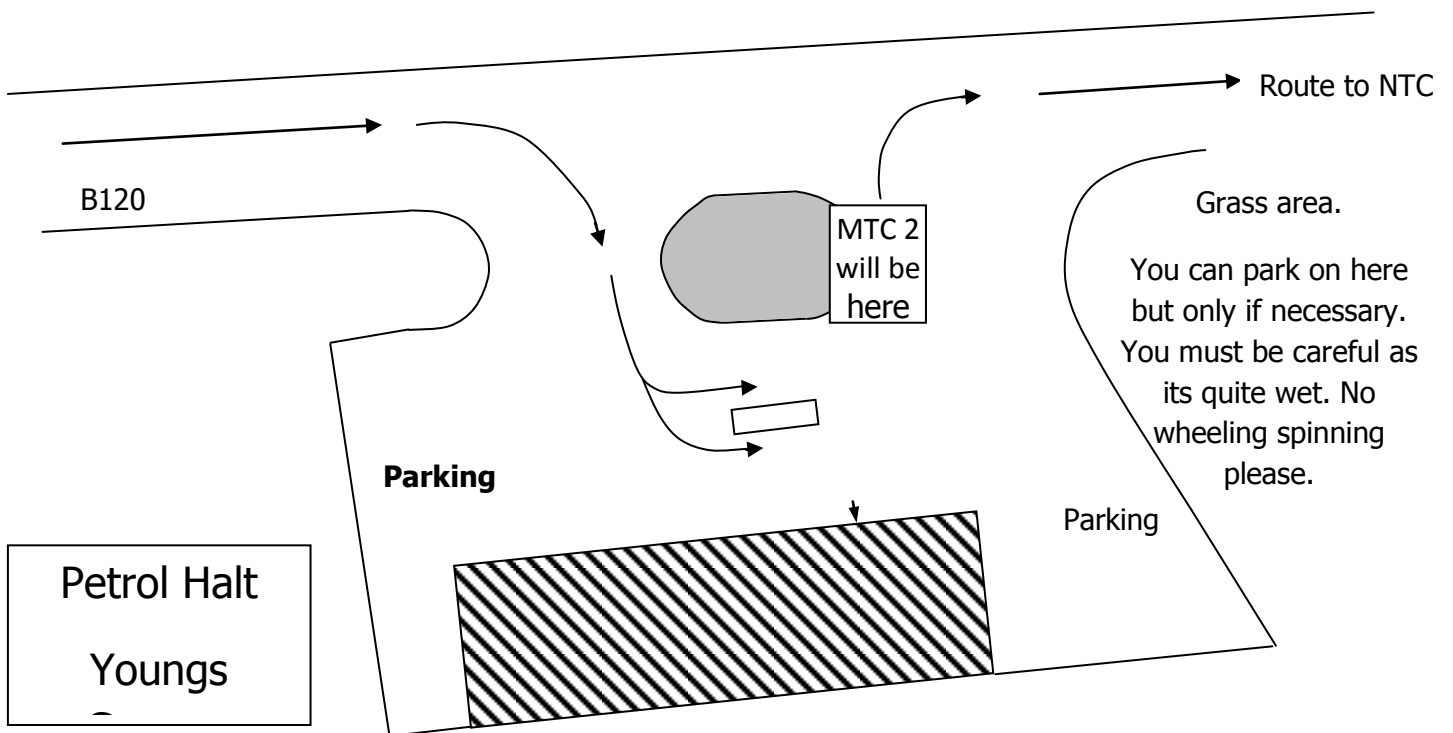



LINCOLN MOTORCYCLE AND CAR CLUB LTD  
**BRUCE ROBINSON ROAD RALLY 14/15th FEB 2009**

A round of the ANEMMC, EMAMC & ANCC  
Road Rally Championships 2009



Route Card: 14

Handout at: MTC 2

CRO

Proceed to NTC 27 **via** the following:

- a) **VERY QUIET TEALBY**
- b) W 15759085 N (this is the second junction, found after the church.)
- c) **VERY QUIET**
- d) End QUIET just after 90° left.
- e) NTC 27 @ SE 15759165 NNW

2<sup>nd</sup> Half Region Points

STC 35 @Map 113 NW 258936

RTC 40 @ Map 121 NE 17408435

MRTC 3 @ The Pyewipe Inn, Map 121 NW 949724, accessible from A57  
@946732 (Quiet and care over speed bumps)



LINCOLN MOTORCYCLE AND CAR CLUB LTD  
**BRUCE ROBINSON ROAD RALLY 14/15th FEB 2009**  
A round of the ANEMMC, EMAMC & ANCC  
Road Rally Championships 2009



Route Card: 15

Handout at: NTC 27

AR

Proceed to STC 28 **via** the following Herringbone:

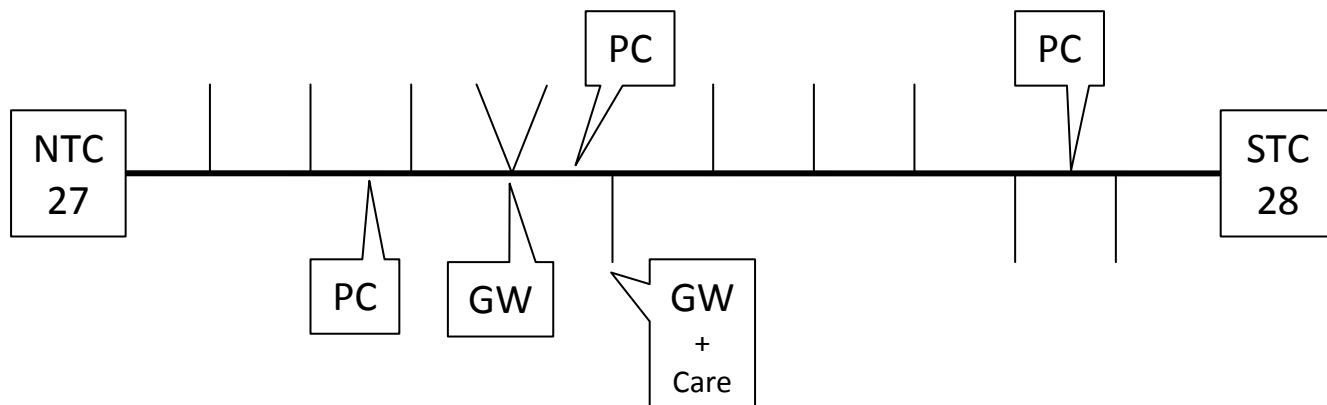



**LINCOLN MOTORCYCLE AND CAR CLUB LTD**  
**BRUCE ROBINSON ROAD RALLY 14/15th FEB 2009**  
 A round of the ANEMMC, EMAMC & ANCC  
 Road Rally Championships 2009



Route Card: 16

Handout at: STC 28

AR

**Via the following unless told otherwise in reverse alphabetical order to reach STC's 29 and 30.**

U Red Dot	K Green Dot	R PC	V PC
H Green Dot	W Red Dot	Z GW	G Green Dot
O Green Dot + PC	D SH 104 Depart WNW	P Green Dot	M Green Dot
L STC 29	J Green Dot	C STC 30 @ SE 15909965	I Green Dot
S GW onto Yellow	F Green Dot	X Red Dot	E PC
Y Red Dot	Q Avoid a Place of Worship with spire, minaret or dome	T PCNAM as per diagram below	N Green Dot

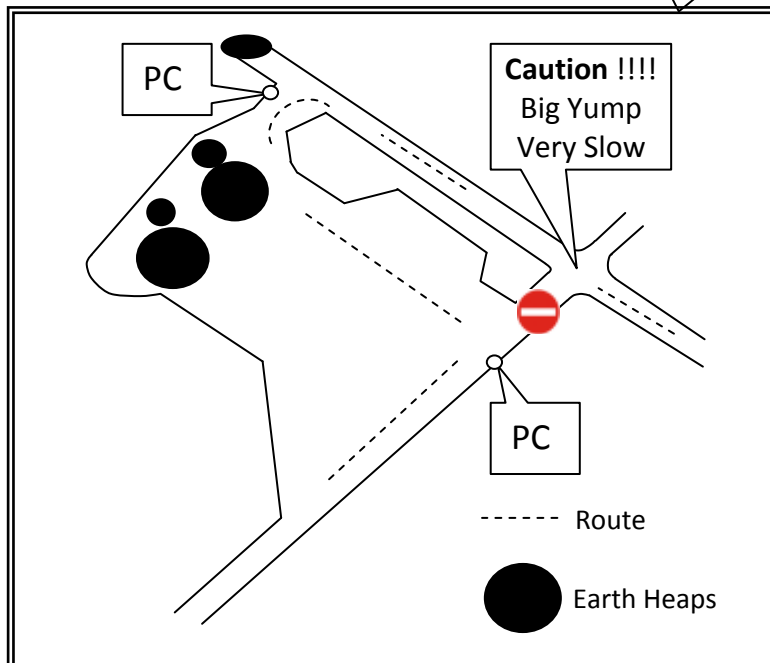

Then Neutral section to NTC 31 via:

1. 155998 (Quiet),
2. SH 76, and
3. 17350095 (Very Quiet)
4. NTC 31 @ NW 17650090



LINCOLN MOTORCYCLE AND CAR CLUB LTD  
**BRUCE ROBINSON ROAD RALLY 14/15th FEB 2009**  
A round of the ANEMMC, EMAMC & ANCC  
Road Rally Championships 2009



Route Card: 17

Handout at: NTC 31

AR

Proceed to STC's 32 and 33 using the following, in **ascending numerical** order:

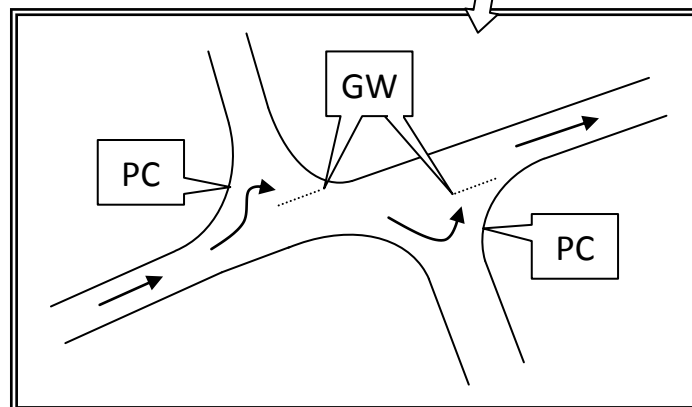
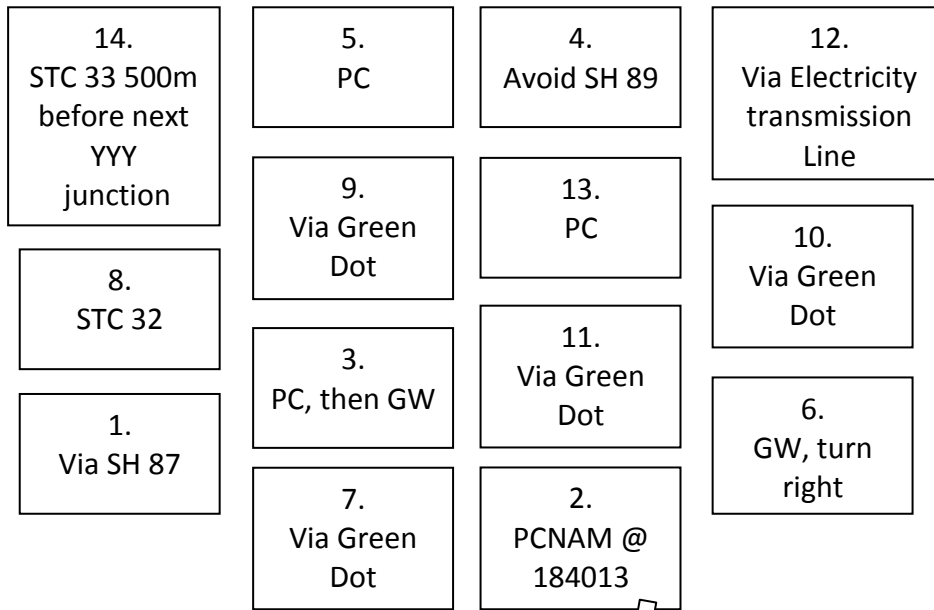

Then Neutral section to NTC 34 via:

- 1) Very Quiet through next village
- 2) 22059765 Turn Right onto B1203
- 3) Quiet past Public House
- 4) NTC 34 @ N 22259650



LINCOLN MOTORCYCLE AND CAR CLUB LTD  
**BRUCE ROBINSON ROAD RALLY 14/15th FEB 2009**  
A round of the ANEMMC, EMAMC & ANCC  
Road Rally Championships 2009



Route Card: 18

Handout at: NTC 34

AR

Proceed to STC 35 **via** the tulips below in the following order:

3	6	8
7	5	1
4	9	2

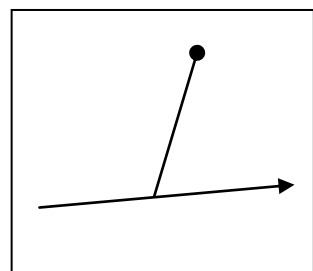
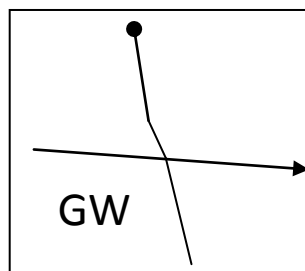
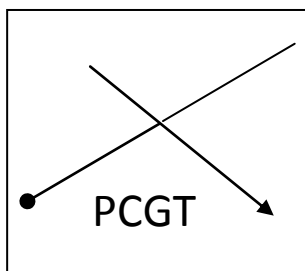
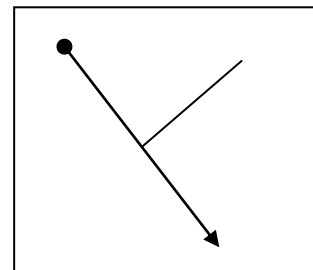
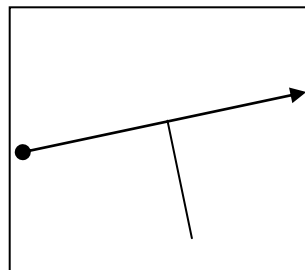
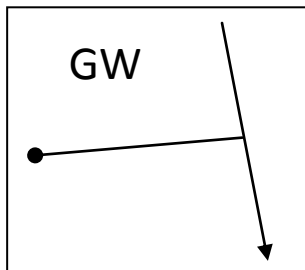

QUIET @  
Cold  
Harbour

STC 35

PC



LINCOLN MOTORCYCLE AND CAR CLUB LTD  
**BRUCE ROBINSON ROAD RALLY 14/15th FEB 2009**



A round of the ANEMMC, EMAMC & ANCC  
 Road Rally Championships 2009

Route Card: 19

Handout at: STC 35

CRO (Expect in  
 NAM diagram below)

Proceed to STC's 36, 37 and 38 **via** the following northing's (i.e. forget about the easting's) in **numerical** order. **Beware: The route plots several ways to begin but there is only one correct route which prevails. You have been warned, plot carefully!!!**

1	PC	2	GW	3	93	4	PC	5	NAMPC in entrance to white on LHS	6	92
7	STC 36	8	91	9	91	10	PC	11	92	12	PCNAM (diagram below)
13	93	14	STC 37	15	94	<div data-bbox="842 965 1513 2101" data-label="Diagram"> <p><b>KEY</b>   = Building   = Route</p> <p>N</p> <p>Silos</p> <p>PC</p> <p>25609245</p> <p>GW when rejoining onto yellow both times</p> <p>Yellow</p> <p>25559230</p> <p>PC</p> </div>					
16	PC	17	94	18	GW						
19	93	20	92	21	PC						
22	91	23	90	24	PC						
25	GW	26	89	27	88						
28	STC 38 @ NNW 209879										



LINCOLN MOTORCYCLE AND CAR CLUB LTD  
**BRUCE ROBINSON ROAD RALLY 14/15th FEB 2009**  
 A round of the ANEMMC, EMAMC & ANCC  
 Road Rally Championships 2009



To reach IRTC39 & RTC40 use the following:

- Via map across the airfield from STC38**  
 a) Then GW turn **left** onto B1225 @ 195876  
 b) GW onto A157 @ 20558605  
 c) Turn right onto yellow @ 18358440 (V. Quiet)  
 d) Turn left @ 18158460 (V. Quiet)  
 e) F) RTC 40 @ 17408435

f) IRTC39 on the correct route  
 This is a Regularity  
 Section!

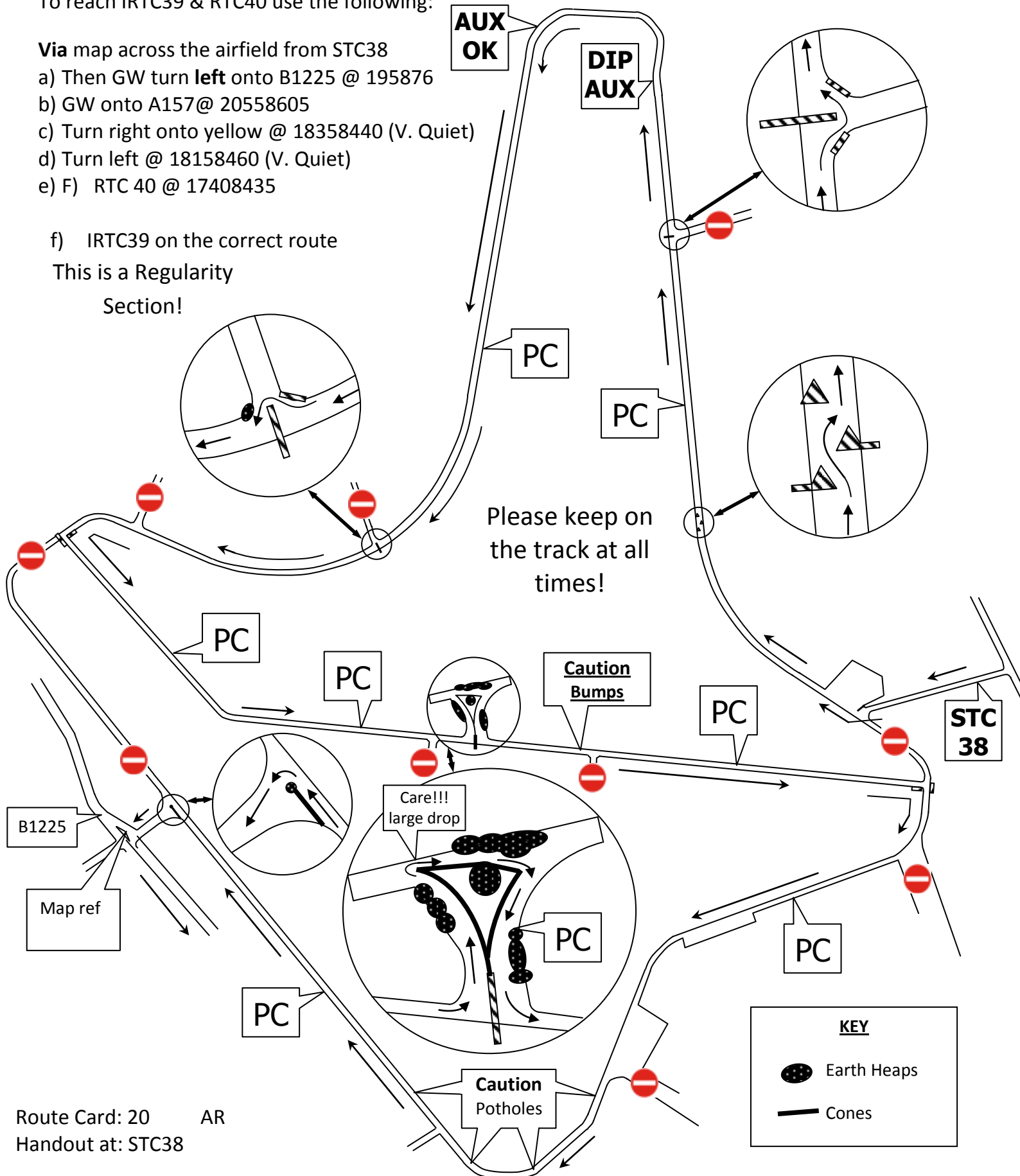

Route Card: 20 AR  
 Handout at: STC38



LINCOLN MOTORCYCLE AND CAR CLUB LTD  
**BRUCE ROBINSON ROAD RALLY 14/15th FEB 2009**  
A round of the ANEMMC, EMAMC & ANCC  
Road Rally Championships 2009



Route Card: 21

Handout at: RTC 40

CRO

Proceed to STC's 41 and 42 **via** the following:

PC GW IV 38 C STC41@OO GW PC 26 STC 42 in 1281

Then Neutral Section to NTC 43 via:

1. B1202 and B1399 (VERY QUIET, HOLTON CUM BECKERING)
2. To NTC 43 @ 10558075 (airfield entrance)



Route Card: 22

Handout at: NTC43

AR

This is a Regularity Section!

Proceed to RTC 45 **via** the following in alphabetical order.

IRTC 44 will be found on the correct route.

**The Code Boards on this section are 2 lettered apart from the 5<sup>th</sup> and 6<sup>th</sup> PC's which are 5 lettered.**

<p>A</p> <p>Follow attached map.</p>	<p>B</p> <p>Leave attached map at 104802 and GW and turn right onto B1399.  (CRO from now)</p>	<p>C</p> <p>Very Quiet Past Fulnetby Hall</p>
<p>D</p> <p>Turn right @ 091790  (Still Very Quiet)</p>	<p>E</p> <p>RTC 45 @ 08907945</p>	

Please Note:  
  
This route card was printed on A5 and attached to an A3 map of the airfield



LINCOLN MOTORCYCLE AND CAR CLUB LTD  
**BRUCE ROBINSON ROAD RALLY 14/15th FEB 2009**

A round of the ANEMMC, EMAMC & ANCC  
 Road Rally Championships 2009



Route Card: 23

Handout at: RTC 45

AR

Proceed to STC's 46 and 47 **via** the following tulip diagrams in **ascending numerical order, beginning at 0 (zero).**

40 	175 STC 47	75 	155 	15 PC	50 
5 	95 	120 	25 GW 	110 GW 	145 End Quiet
140 	45 Care @ LC	60 	90 GW (CARE) 	130 	35 
70 PC	160 	65 	0 	150 PC	80 STC 46
30 Quiet Snelland	85 	170 GW 	100 	20 GW 	165 
125 Quiet Cold Hanworth	10 	135 	105 PC	115 	55 End Quiet

Then Transport Section to TTC 48 via:

1. VERY QUIET HACKTHORN
2. Turn left onto A15 @ 97958140
3. Turn right a@ round-a-bout @ 97357820
4. Turn left onto B1398
5. Turn right at SH 56
6. VERY QUIET NORTH CARLTON
7. **TTC 48 @ 92757725**



LINCOLN MOTORCYCLE AND CAR CLUB LTD  
**BRUCE ROBINSON ROAD RALLY 14/15th FEB 2009**

A round of the ANEMMC, EMAMC & ANCC  
Road Rally Championships 2009



Route Card: 24

Handout at: TTC 48

AR

This is a regularity section!

Proceed to MRTC 3 **via** the following Grid Lines in order from right to left:  
IRTC 49 will be found on the correct route.

74 94 PC 75 PC 93 PC 93 76 PC 93 PC 93 PC 93 77

Caution @ 90  
left over  
bridge

Then: Give Way and turn right onto yellow.

Give Way turn left @ round-a-bout

Turn right onto white @ 94557320

CAUTION SEVERE SPEED BUMPS!

Very Quiet past bungalow @ 94657265

**MRTC 3 and Finish Venue @ 949724**

**MRTC 3 will be inside the venue**

Please remember to bring your completed Damage Declaration form inside  
along with Time Card 2 and Passage Check sheet 2.

We hope you have enjoyed the 2009 'Bruce.'  
Sit back and relax, enjoy your breakfast and await the results!