



LINCOLN MOTORCYCLE AND CAR CLUB LTD
BRUCE ROBINSON ROAD RALLY 9/10th FEB 2008

A round of the ANEMMC, EMAMC & ANCC
 Road Rally Championships 2008



ROUTE CARD: 1

HANDOUT AT: MTC1

AR

Via the following to reach **NTC 2**.

<u>Map Reference</u>	<u>Comments</u>
92656875	Give Way
92456880	Give Way @ Round-a-bout onto A46
95307275	Give Way @ Round-a-bout onto A57
93607375	Give Way, turn right onto yellow
941740	NTC 2, on white

Then use the following to reach **RTC 4**, **IRTC 3** will be found on the correct route.

This is a Regularity Section!

93507455	PC
93207525	PC
92657535	PC
93107580	PC
93207585	90 Left CAUTION BIG DITCH
92907630	PC
92857645	90 Right CAUTION OVER BRIDGE
93207655	90 Left CAUTION BIG DITCH
92757730	Give Way, turn right
	Very QUIET NORTH CARLTON
95157755	Give Way, turn left, CARE
95357835	Give Way, turn right
97307815	Give Way, straight over Round-a-bout
97507815	QUIET past houses and on to RTC 4 before Grid Line 98

1st Half Region Points

TTC 16 @ Map 122 NW 30157475

TTC23 @ Map 122 SE 300857

Petrol Halt and MTC2 is @ Map 113 14209040



LINCOLN MOTORCYCLE AND CAR CLUB LTD
BRUCE ROBINSON ROAD RALLY 9/10th FEB 2008
A round of the ANEMMC, EMAMC & ANCC
Road Rally Championships 2008



ROUTE CARD: 2

HANDOUT AT: RTC 4

CRO

Via the following **Grid Lines** to reach STC 5:

98PC99PC00PC78STC5

Then Transport section to TTC 6 @ WNW 05908180
via 00507795 (GW and Quiet) and 036803.



LINCOLN MOTORCYCLE AND CAR CLUB LTD
BRUCE ROBINSON ROAD RALLY 9/10th FEB 2008
 A round of the ANEMMC, EMAMC & ANCC
 Road Rally Championships 2008



ROUTE CARD: 3

HANDOUT AT: TTC 6

AR

Proceed from TTC 6 @ 05908180 to STC 8 **via** the following **Tulips** in **ascending numerical order**:

1) 	16) 	15) 	14) 	13) GW
2) PC	17) PC		23) STC 8 @10558100 (on white)	12) STC 7
3) 	18) GW 		22) 	11)
4) 	19) PC	20) 	21) 	10)
5) QUIET SNELLAND	6) 	7) 	8) 	9) QUIET END



LINCOLN MOTORCYCLE AND CAR CLUB LTD
BRUCE ROBINSON ROAD RALLY 9/10th FEB 2008
 A round of the ANEMMC, EMAMC & ANCC
 Road Rally Championships 2008



ROUTE CARD: 4

HANDOUT AT: STC8

AR

This is a Regularity Section!

Proceed to RTC 10 **via** the following.
 IRTC 11 will be found on the correct route.

<p>A</p> <p>GW and turn left back onto yellow.</p>	<p>B</p> <p>After approx. 150 metres turn right onto white @106808.</p>	<p>C</p> <p>Follow attached map.</p>
<p>D</p> <p>Leave attached map at 104802 and GW and turn right onto B1399.</p>	<p>E</p> <p>Turn left at next coloured junction. Very QUIET through Rand</p>	<p>F</p> <p>GW and turn left onto A158.</p> <p>RTC 10 @ N 112780</p>

This Route Card was on A5 attached to an A3 map of the airfield.



LINCOLN MOTORCYCLE AND CAR CLUB LTD
BRUCE ROBINSON ROAD RALLY 9/10th FEB 2008

A round of the ANEMMC, EMAMC & ANCC
Road Rally Championships 2008



ROUTE CARD: 5

HANDOUT AT: RTC 10

CRO

Via the following from **top to bottom** to reach STC 12.
STC 11 will be found on the correct route.

Give Way, Turn Right, QUIET and NO STOPPING @ 1 st junction.
PCNAM (diagram below) @ 11407635
PC
Give Way @ SH 9
SH 6
Give Way and then VERY QUIET Stainfield
SH 6 VERY QUIET Stainfield
End QUIET and Give Way
SH 5
STC 12 @ NW 114719

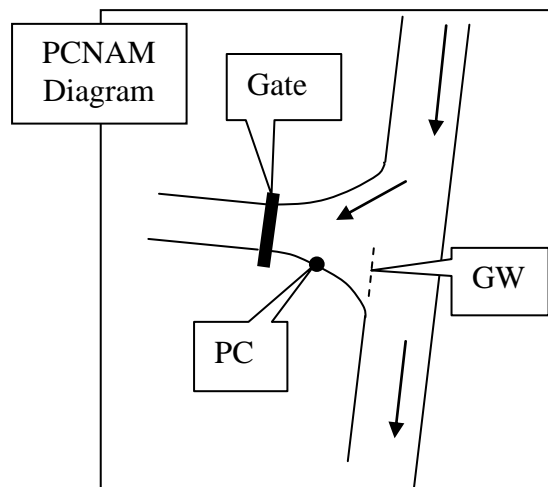



LINCOLN MOTORCYCLE AND CAR CLUB LTD
BRUCE ROBINSON ROAD RALLY 9/10th FEB 2008

A round of the ANEMMC, EMAMC & ANCC
Road Rally Championships 2008



ROUTE CARD: 6

HANDOUT AT: STC 12

CRO

Via the following **grid squares** in **alphabetical** order to reach STC 13:

A 1171	K 1572	G 1471	O 1671
E 1371	I 1472	M 1672	C 1271

GW at 1st Junction
PC's in Grid Square's E and M
STC 13 in Grid Square O



LINCOLN MOTORCYCLE AND CAR CLUB LTD
BRUCE ROBINSON ROAD RALLY 9/10th FEB 2008
A round of the ANEMMC, EMAMC & ANCC
Road Rally Championships 2008



ROUTE CARD: 7

HANDOUT AT: STC 13

AR

Via the following **herringbone** to reach STC 14

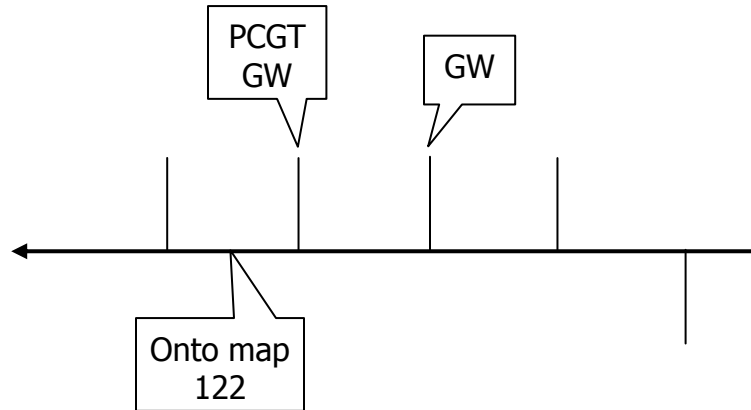



LINCOLN MOTORCYCLE AND CAR CLUB LTD
BRUCE ROBINSON ROAD RALLY 9/10th FEB 2008

A round of the ANEMMC, EMAMC & ANCC
 Road Rally Championships 2008



ROUTE CARD: 8

HANDOUT AT: STC 14

CRO

Via the following **Map References** in **alphabetical** order to reach STC 15

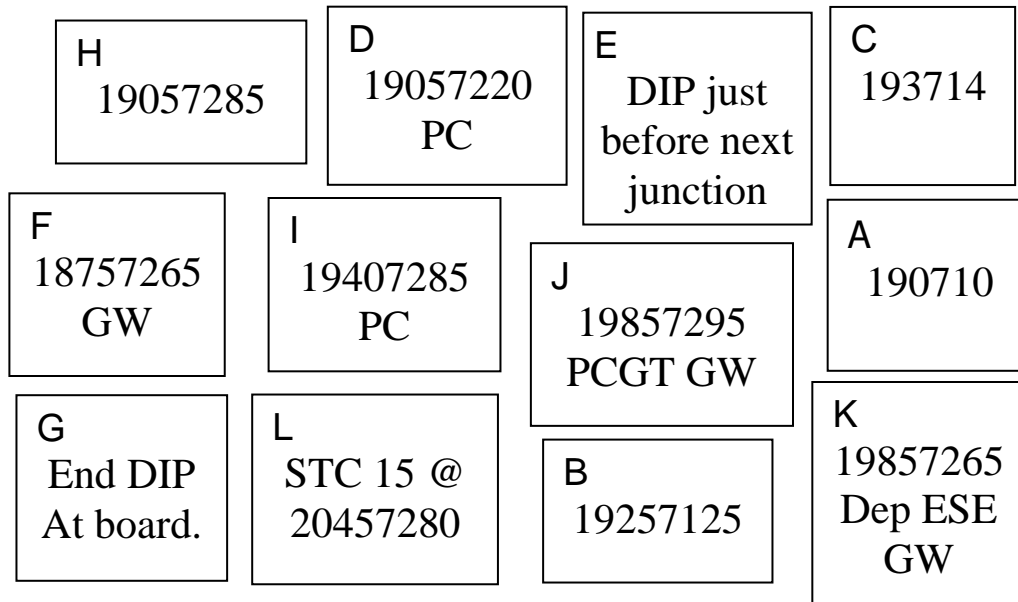

Hand in Time Card 1 and Passage Check sheet 1 at STC 15.
 Ensure the marshal transfers your time at STC15 onto Time Card 2.

Then **Transport** section:

22257405	Give Way, turn right onto A158, QUIET
24157135	Turn left onto yellow
264720	Give Way, turn left onto A153, QUIET
27507535	Turn right onto yellow
	QUIET BELCHFORD
295754	Turn right, QUIET
	End QUIET after village
30157475	TTC 16



LINCOLN MOTORCYCLE AND CAR CLUB LTD
BRUCE ROBINSON ROAD RALLY 9/10th FEB 2008

A round of the ANEMMC, EMAMC & ANCC
Road Rally Championships 2008



ROUTE CARD: 9

HANDOUT AT: TTC16

CRO

Avoid the following **grid squares** in order from **top to bottom** to reach
STC 17 and STC 18 which will be found on the correct route.

3073 East Half

2973

3072 East Half

2972

3070

3172

3271 South Half

PC's located after 1st and 2nd junctions. PCGT @ 4th coloured junction.
Give Way at 3rd junction.



LINCOLN MOTORCYCLE AND CAR CLUB LTD
BRUCE ROBINSON ROAD RALLY 9/10th FEB 2008

A round of the ANEMMC, EMAMC & ANCC
 Road Rally Championships 2008



ROUTE CARD: 10

HANDOUT AT: STC18

AR

Please choose, at your own discretion, either **type A OR type B** navigation to plot.
 Both give exactly the same information and route and so the choice is yours!

Type A

A 33407195 No Stopping	D 32657350 GW	G 32357360	J 32207445 STC 19
B 33757280 PCGT GW	E 32507345	H 31507425 PCGT	
C 33057335 + PC	F 32407355	I 31557435	

Type B

A YYY No Stopping	D YYY GW	G YWY	J 32207445 STC 19
B YYY PCGT GW	E YYY	H YYY PCGT	
C YWY + PC	F YWY	I YWY	

Then neutral section (to be plotted by all):

Proceed to NTC 20 @ 32957600 Via SH54. **VERY QUIET through Tetford.**



LINCOLN MOTORCYCLE AND CAR CLUB LTD
BRUCE ROBINSON ROAD RALLY 9/10th FEB 2008
 A round of the ANEMMC, EMAMC & ANCC
 Road Rally Championships 2008



ROUTE CARD: 11

HANDOUT AT: NTC 20

CRO

All **Via** unless told **Avoid** in the following order:

D3, B2, B4, D5, A3, D2, C5, C3, A1, D1, A5, B1, D4, C1, A2, C2, A4, B3, C4, B5

	1	2	3	4	5
A	SH 132 PCGT GW	SH 133	AVOID SH 109	SH 144	STC 21
B	SH 133	<u>PC</u>	SH 137	 142 GIVE WAY	STC 22
C	SH 148	PCGT West side at crossroads Give Way	Map Ref 31107635	SH 148	PC in lay-by @ Viewpoint Care kerbs!
D	SH 137	PC in Lay-by near side of road @ 323761	START NTC20 @ 32957600	<u>PC</u>	AVOID SH 56

Then Transport section:

Turn right onto A153 and proceed to TTC23 @ SE 300857 via:
 SSW 31858595 WNW and E 30258560

Very Quiet Hubbards Hills and Hallington



LINCOLN MOTORCYCLE AND CAR CLUB LTD
BRUCE ROBINSON ROAD RALLY 9/10th FEB 2008

A round of the ANEMMC, EMAMC & ANCC
Road Rally Championships 2008





ROUTE CARD: 12

HANDOUT AT: TTC 23

AR

Via the following **grid lines** and **spot heights** in **reverse alphabetical** order to reach STC 24

A STC 24 before GL 26	I GL 29	D Care past houses, parked cars	J  111
E SH 115		L TTC 23	H, F PC
G GL 28	K PCGT at 1 st junction	C GL 85	B GL 27



LINCOLN MOTORCYCLE AND CAR CLUB LTD
BRUCE ROBINSON ROAD RALLY 9/10th FEB 2008

A round of the ANEMMC, EMAMC & ANCC
Road Rally Championships 2008



ROUTE CARD: 13

HANDOUT AT: STC 24

AR

Via the following **herringbone** in order to reach STC's 25 and 26

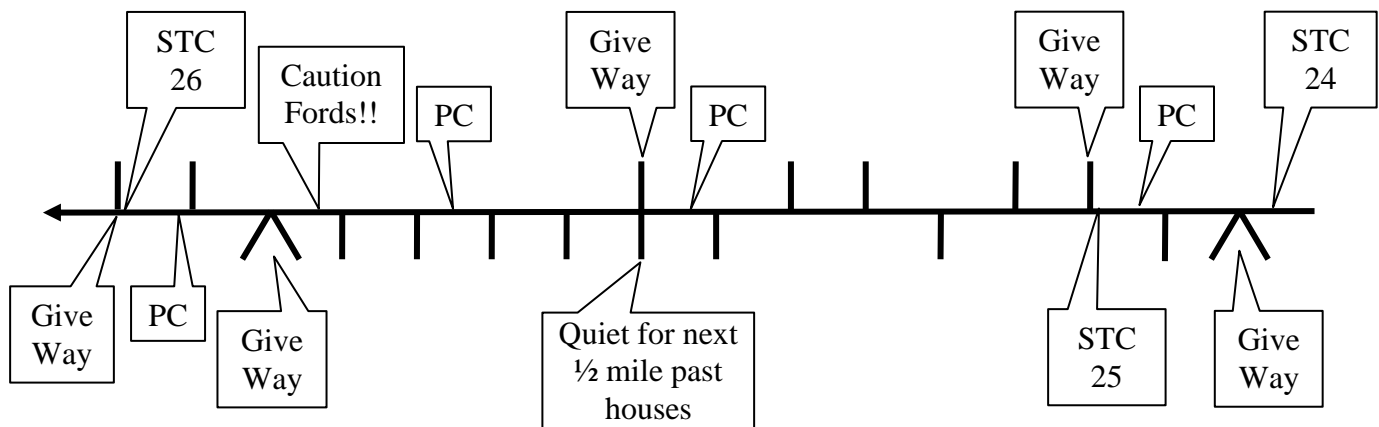

Then NEUTRAL section via 21658635,
Very QUIET Burgh on Bain to NTC 27 @ SE 209879 W (onto airfield)
Perhaps now would be a suitable time to change to map 113!!!



LINCOLN MOTORCYCLE AND CAR CLUB LTD
BRUCE ROBINSON ROAD RALLY 9/10th FEB 2008



A round of the ANEMMC, EMAMC & ANCC
 Road Rally Championships 2008

To reach IRTC28 & RTC29 use the following:

Via map across the airfield from NTC27
 Then GW turn right onto B1225 @ 195876
 GW @ SE 1855885
 Turn left onto white @ 18058955 (Quiet)
 RTC 29 @ ENE 17858945

IRTC28 on the correct route

This is a Regularity
 Section!

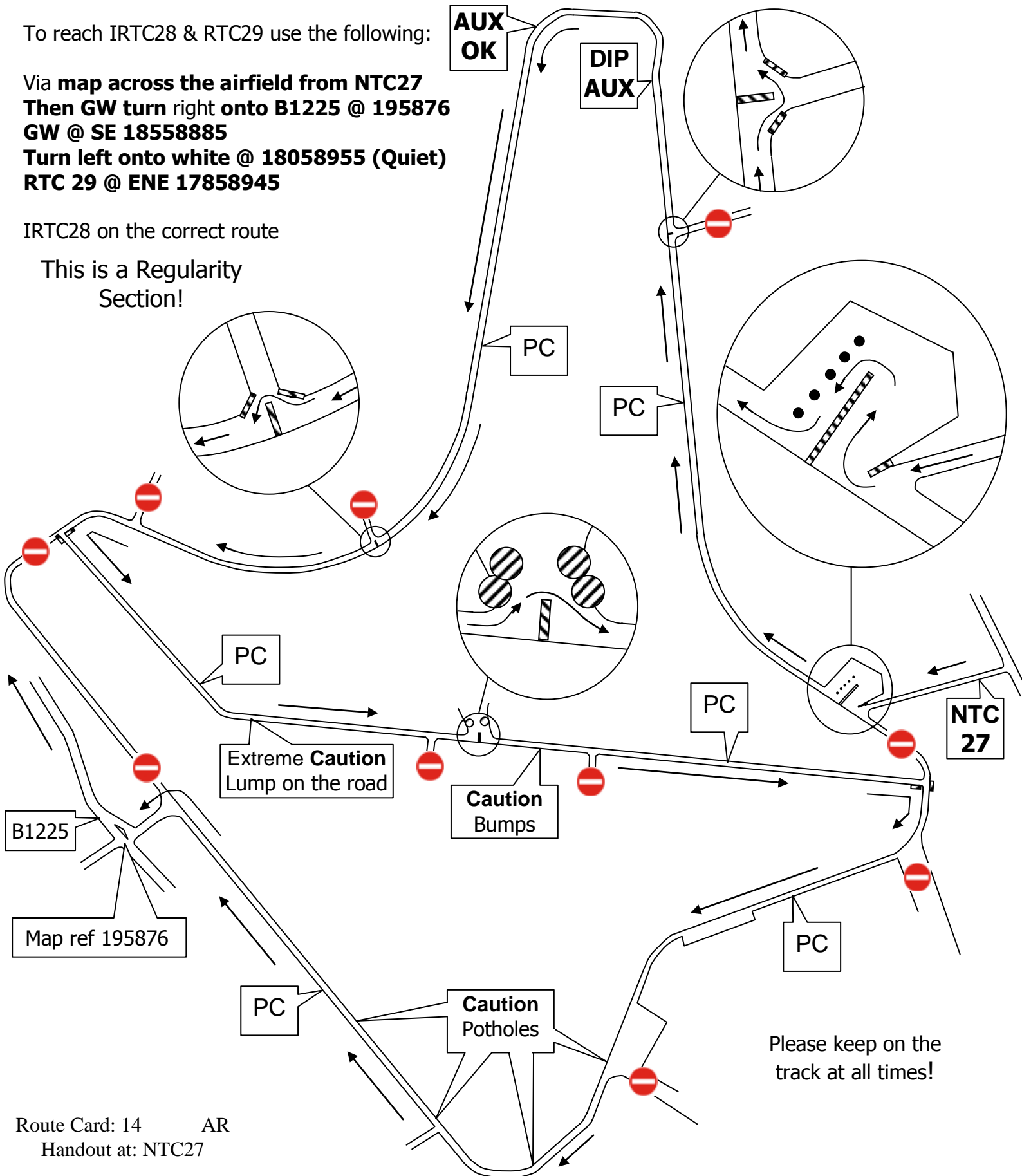

Please keep on the
 track at all times!



LINCOLN MOTORCYCLE AND CAR CLUB LTD
BRUCE ROBINSON ROAD RALLY 9/10th FEB 2008



A round of the ANEMMC, EMAMC & ANCC
 Road Rally Championships 2008

To reach IRTC30, RTC 31 + the Petrol halt use the following:

Route Card: 15 AR
 Handout at: RTC29

- A) **Via map** from RTC29 until the A631 @ 18208875
- B) GW, Turn right onto the A631
- C) RTC 31 @ 13658840 but is unmanned so proceed straight to petrol
- D) GW, turn right and quiet @ 109891 (traffic lights)
- E) Petrol Halt @14209040 (see diagram of petrol halt on **reverse** of this sheet)

IRTC30 on the correct route.

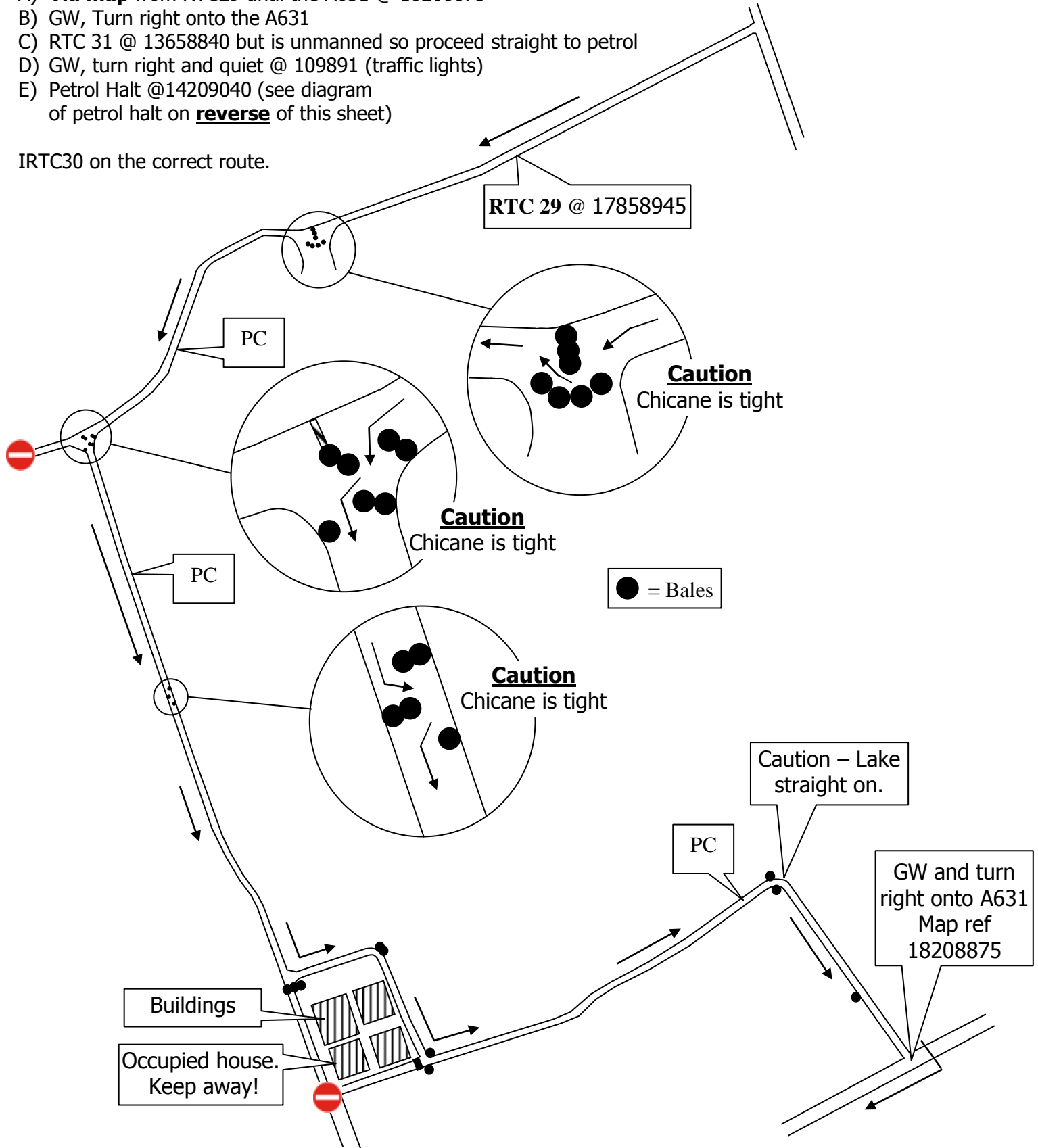



LINCOLN MOTORCYCLE AND CAR CLUB LTD
BRUCE ROBINSON ROAD RALLY 9/10th FEB 2008
A round of the ANEMMC, EMAMC & ANCC
Road Rally Championships 2008



ROUTE CARD: 16

HANDOUT AT: MTC2

CRO

Proceed to NTC 32 **via** the following:

- a) **VERY QUIET TEALBY**
- b) W 15759085 N (this is the second junction found after the church.)
- c) **VERY QUIET**
- d) End QUIET just after 90° left.

NTC 32 @ SE 15759165 NNW

2nd Half Region Points

STC 43 @ Map 122 WSW 23158015

TTC 49 @ Map 121 NE 10908075

MRTC 51 @ Map 121 The George Inn Langworth 06407660



LINCOLN MOTORCYCLE AND CAR CLUB LTD
BRUCE ROBINSON ROAD RALLY 9/10th FEB 2008
 A round of the ANEMMC, EMAMC & ANCC
 Road Rally Championships 2008







ROUTE CARD: 17

HANDOUT AT: NTC32

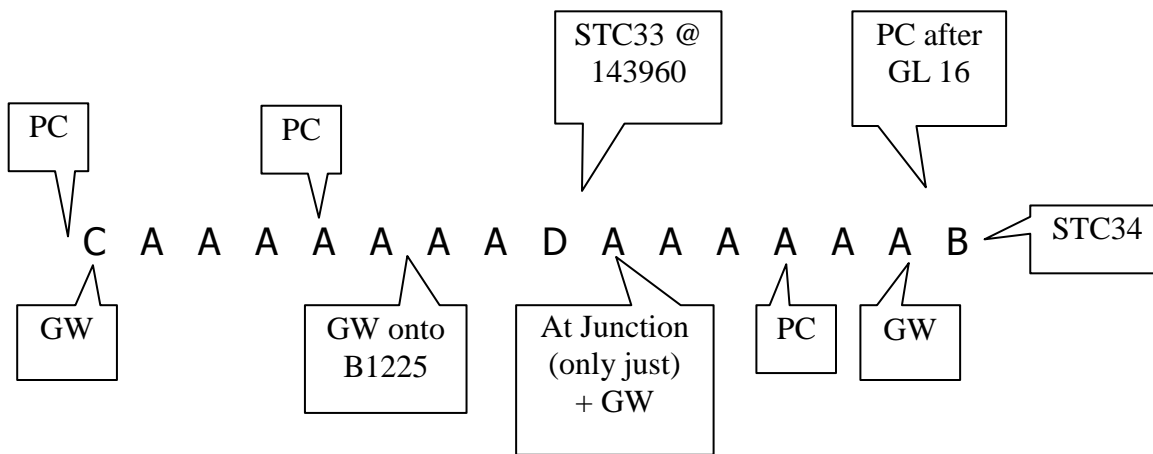
CRO

Via the map features in the grid below in the following order from left to right:



<p>A)</p> <p>Green Dot</p> 	<p>B)</p> <p>Triangulation Pillar 124</p> 	<p>C)</p> <p>Mast</p> 	<p>D)</p> <p>Spot Height 158</p>
--	--	--	--------------------------------------



LINCOLN MOTORCYCLE AND CAR CLUB LTD
BRUCE ROBINSON ROAD RALLY 9/10th FEB 2008
 A round of the ANEMMC, EMAMC & ANCC
 Road Rally Championships 2008



ROUTE CARD: 18

HANDOUT AT: STC34

AR

Via the following in **alphabetical** order:

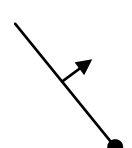
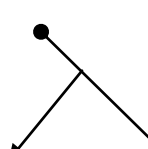
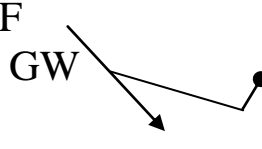
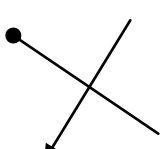
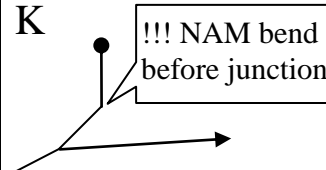
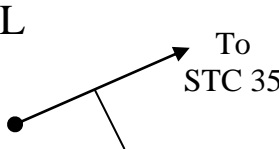
A  GW	B 	C NAM Diagram 1	D PC @ 3 rd Red dot
H PC	G 	F GW 	E 
I NAM Diagram 2 @17759470	J PC	K  !!! NAM bend before junction	L  To STC 35

NAM Diagram 1

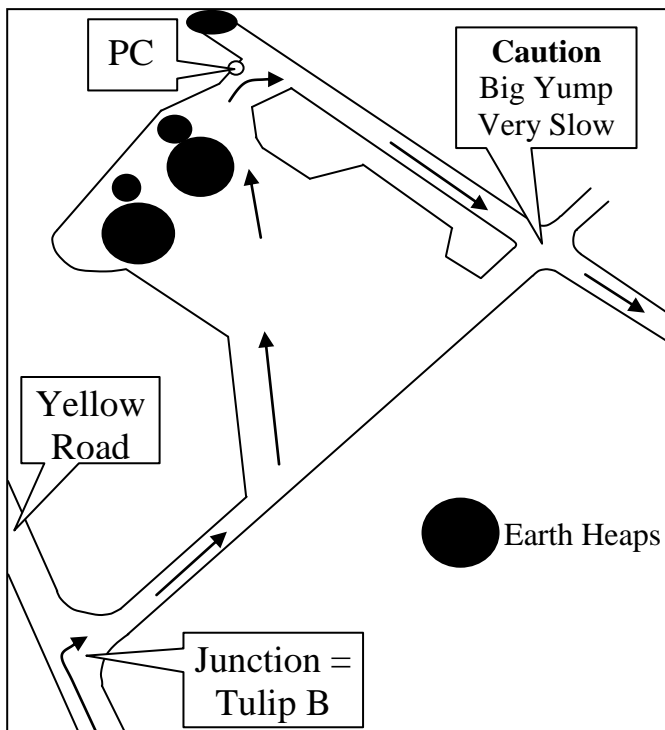

NAM Diagram 2

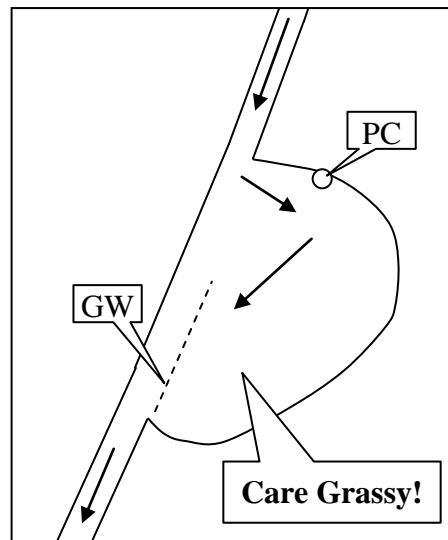

Then Neutral section to NTC36 @ WSW 22059460 via 20759415 and 21259435,
VERY QUIET Binbrook.



LINCOLN MOTORCYCLE AND CAR CLUB LTD
BRUCE ROBINSON ROAD RALLY 9/10th FEB 2008
A round of the ANEMMC, EMAMC & ANCC
Road Rally Championships 2008



ROUTE CARD: 19

HANDOUT AT: NTC36

CRO

Via the following **grid lines** to reach STC 37.

23 24 PC 95 PCGT GW 95 25 94 STC 37



LINCOLN MOTORCYCLE AND CAR CLUB LTD
BRUCE ROBINSON ROAD RALLY 9/10th FEB 2008
 A round of the ANEMMC, EMAMC & ANCC
 Road Rally Championships 2008



ROUTE CARD: 20

HANDOUT AT: STC37

AR

Via the following herringbone to reach STC 38.

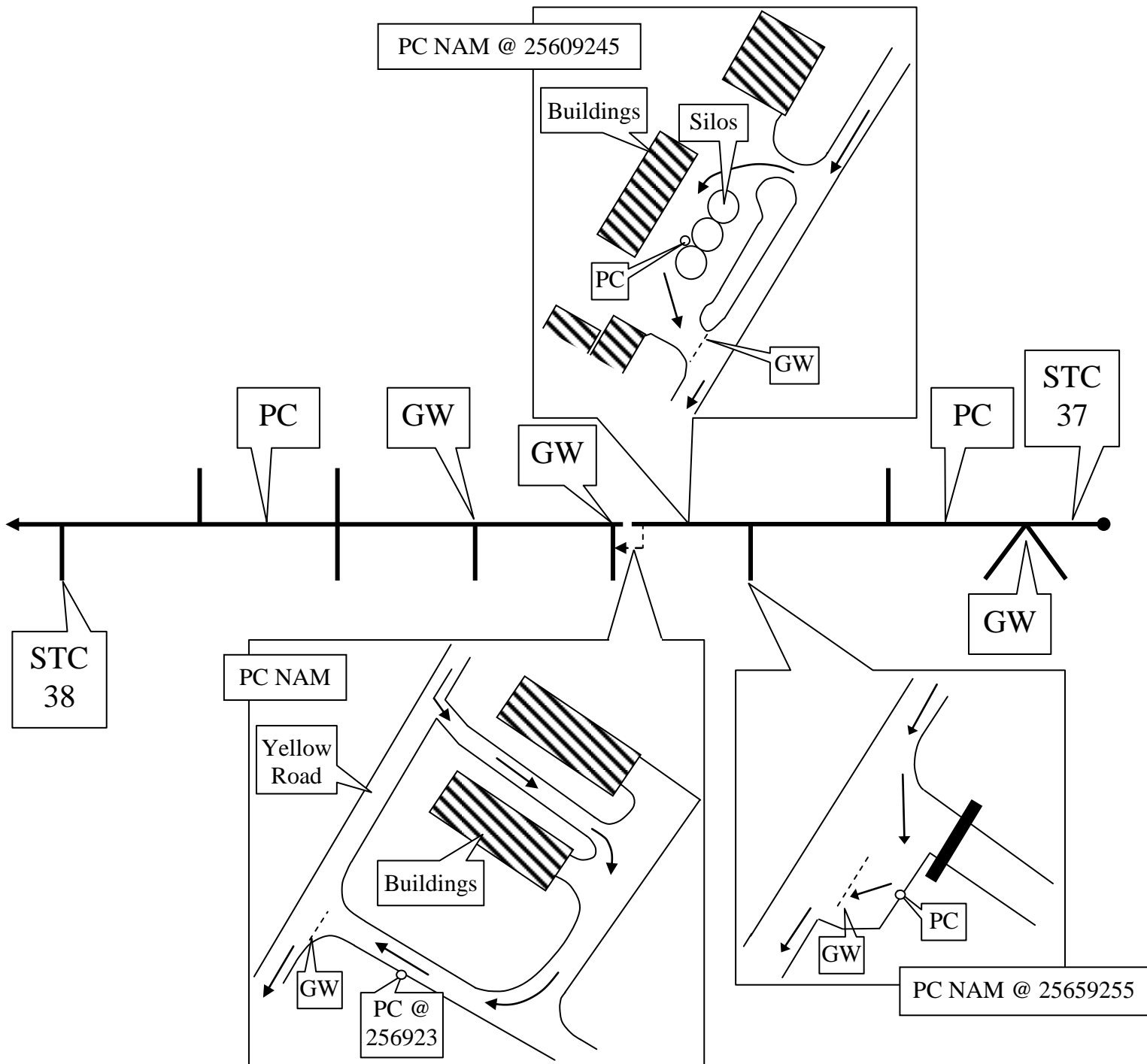



LINCOLN MOTORCYCLE AND CAR CLUB LTD
BRUCE ROBINSON ROAD RALLY 9/10th FEB 2008

A round of the ANEMMC, EMAMC & ANCC
Road Rally Championships 2008



ROUTE CARD: 21

HANDOUT AT: STC38

CRO

Via the following **spot heights** to reach STC 39.

102 132 PC 106 84 GW PC 128 117GW

STC 39 @ NNW 209879 W (onto airfield)



LINCOLN MOTORCYCLE AND CAR CLUB LTD
BRUCE ROBINSON ROAD RALLY 9/10th FEB 2008



A round of the ANEMMC, EMAMC & ANCC
 Road Rally Championships 2008

To reach IRTC40 & RTC41 use the following:

- F) **Via** map across the airfield from STC39
- G) Then GW turn **left** onto B1225 @ 195876
- H) GW @ NNW 20558605
- I) Onto Map 122
- J) RTC 41 @ NNW 21458445

IRTC40 on the correct route

This is a Regularity
 Section!

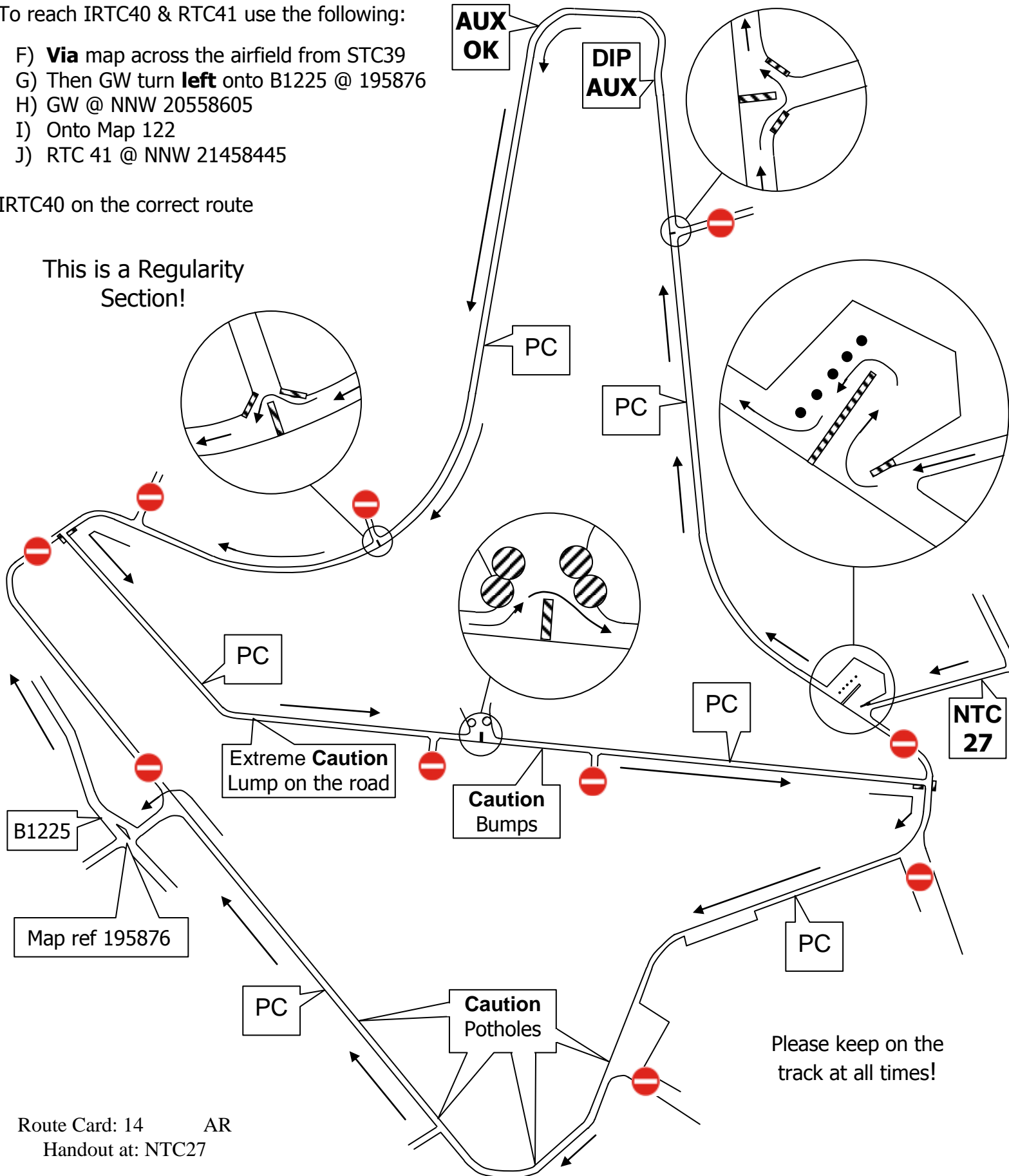

Please keep on the
 track at all times!



LINCOLN MOTORCYCLE AND CAR CLUB LTD
BRUCE ROBINSON ROAD RALLY 9/10th FEB 2008
A round of the ANEMMC, EMAMC & ANCC
Road Rally Championships 2008



ROUTE CARD: 23

HANDOUT AT: RTC41

CRO

Via the following **Spot Heights** to reach STC 42

134 103 PC 81

Then **via** the following **Grid Lines** to reach STC43

GW 82 81 22 80 PC 80 23



LINCOLN MOTORCYCLE AND CAR CLUB LTD
BRUCE ROBINSON ROAD RALLY 9/10th FEB 2008
 A round of the ANEMMC, EMAMC & ANCC
 Road Rally Championships 2008



ROUTE CARD: 24

HANDOUT AT: STC43

AR

Proceed to STC's 44 and 45 **via** the following **tulips** in **numerical** order:

1, 2, 16, 17 	12 	6 	5
13 	14 	3 	18 STC45 @ NE 26308055
8 STC44	10 	4, 11, 15 PC	7, 9

Then Neutral section to NTC46 @ NE 242792 via ENE 256796

Very Quiet Goulceby

From NTC 46 **via** the following **Herringbone** to reach STC's 47 and 48
 Please note the rest of this route card is Coloured Roads Only (CRO)

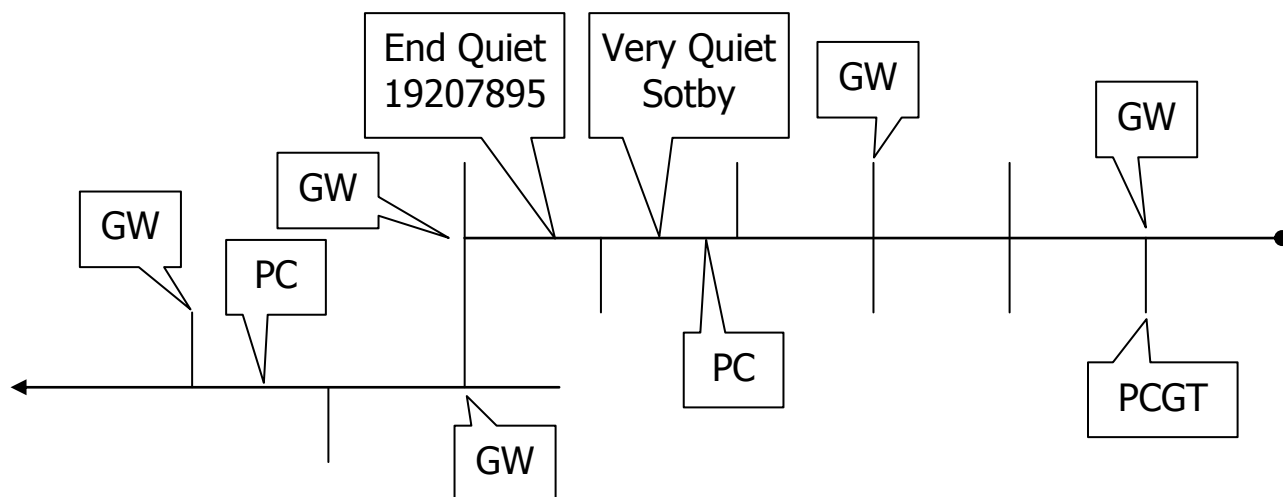

Then **Transport** section **via**:

- GW and turn right onto A158
- Turn Left @ Mini Round-a-bout – 13357810 (Quiet Wragby)
- Turn Right onto B1202 @13207805 (Quiet Wragby)
- Turn Left onto B1399 @ 11658125 (Quiet Holton cum Beckering)
- TTC 49 @ NE 10908075



LINCOLN MOTORCYCLE AND CAR CLUB LTD
BRUCE ROBINSON ROAD RALLY 10/11th FEB 2007
 A round of the ANEMMC, EMAMC & ANCC
 Road Rally Championships 2007



ROUTE CARD: 25

HANDOUT AT: TTC49

AR

This is a Regularity Section!

Proceed to MRTC 3 via the following.
 IRTC 50 will be found on the correct route.

<p>A</p> <p>Turn right onto yellow @ SH 29</p>	<p>B</p> <p>After approx. 250 metres turn left onto white @106808.</p>	<p>C</p> <p>Follow attached map.</p>
<p>D</p> <p>Leave attached map @ 104802 GW and turn right onto B1399.</p>	<p>E</p> <p>GW turn right onto A158 @ N 08607805</p>	<p>F</p> <p>MRTC 51 located inside the finish venue @ the George Inn, Langworth 065766</p>

This Route Card was on A5 attached to an A3 map of the airfield.

We hope you have enjoyed the rally, please enjoy your breakfast and await the results.

The organising team